



# Magnetic Autocontrol GmbH

Grienmatt 20  
D-79650 Schopfheim  
Tel. 07622 6955

Zeichnungsnummer 5526,0029

Kunde

Kommission MicroDrive

Endkunde / Installationsort

Typ MHTM - MicroDrive - Verriegelung -Schrankenbaum  
BV01

Anzahl der Seiten 7

03	16.07.12	5K12526	gp	06.02.2012
02	03.07.12	5K12524	gp	gp
01	15.5.12	5K12517	gp	
Version	Datum	Änderungsprojekt	Name	00 5K12507

MHTM  
MicroDrive



Deckblatt

5526,0029

Blatt 1  
Von 7

MGC, Klemmen, Optokoppler

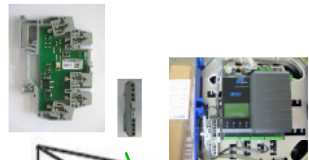

Option rote Baumleuchten

Verriegelung

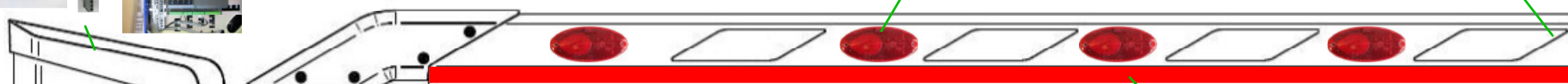

Option Leuchtstreifen



Klemmen im Schrankenbaum



Montageplatte 1



03	16.07.12	5K12526	gp	06.02.2012
02	03.07.12	5K12524	gp	gp
01	15.5.12	5K12517	gp	
Version	Datum	Änderungsprojekt	Name	00 5K12507

MHTM  
MicroDrive



Übersicht

5526,0029

=	
+	
Blatt	2
Von	7

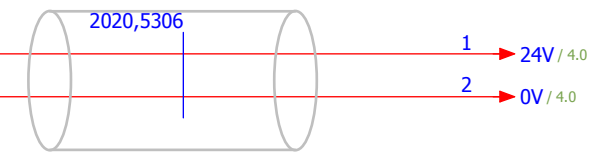

Montageplatte 1

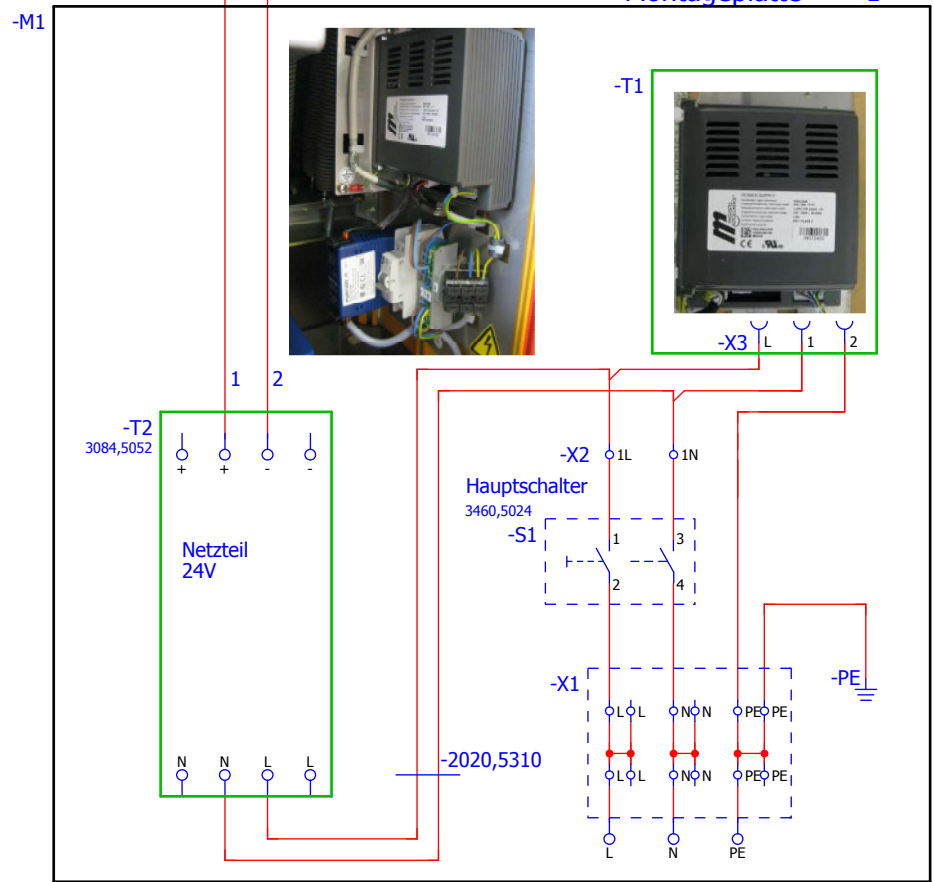

85 - 264V AC 50/60Hz

03	16.07.12	5K12526	gp	06.02.2012
02	03.07.12	5K12524	gp	gp
01	15.5.12	5K12517	gp	
Version	Datum	Änderungsprojekt	Name	00 5K12507

MHTM  
MicroDrive



Hauptanschluss  
Netzteil

	=	
	+	
	5526,0029	Blatt 3
		Von 7

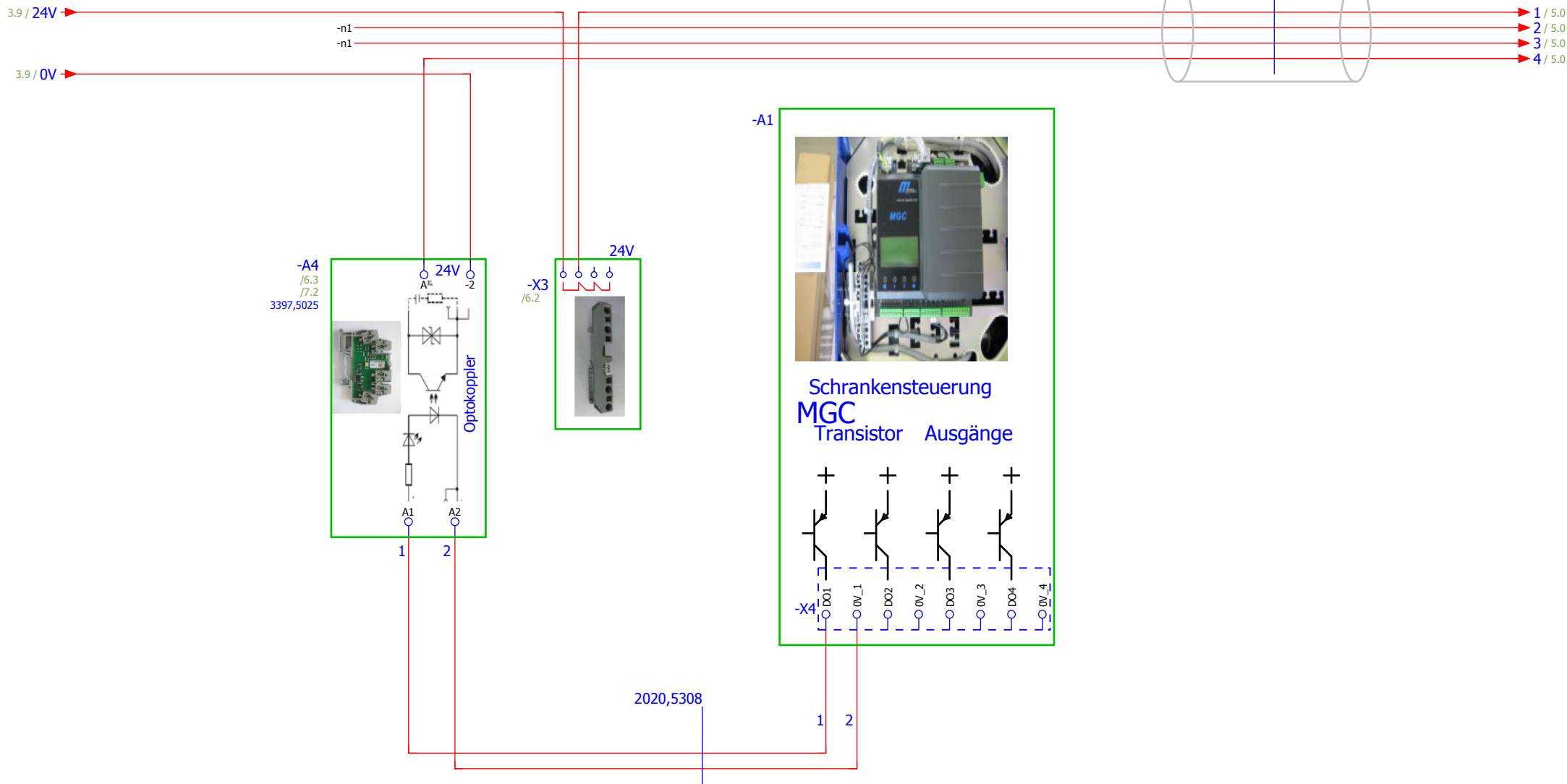

03	16.07.12	5K12526	gp	06.02.2012
02	03.07.12	5K12524	gp	gp
01	15.5.12	5K12517	gp	
Version	Datum	Änderungsprojekt	Name	00 5K12507

MHTM  
MicroDrive



Schrankensteuerung MGC

5526,0029

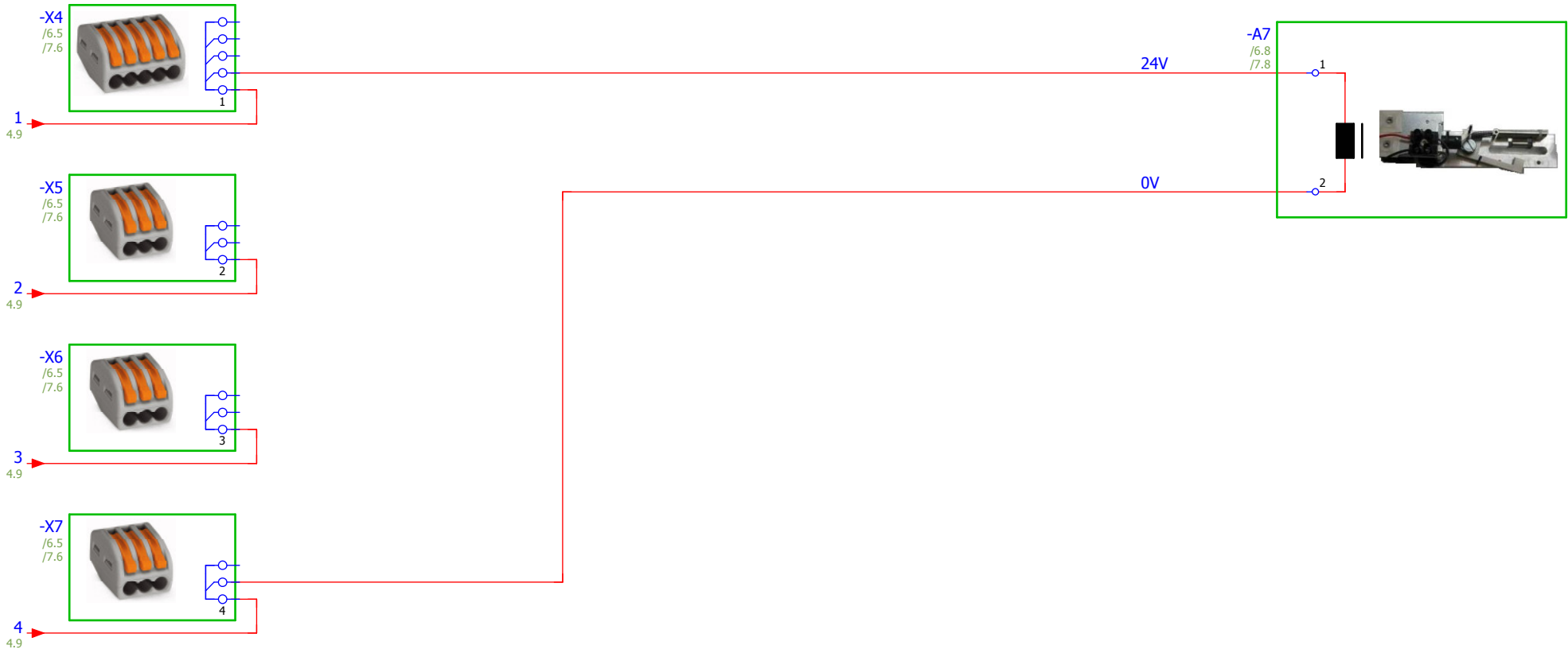

03	16.07.12	5K12526	gp	06.02.2012
02	03.07.12	5K12524	gp	gp
01	15.5.12	5K12517	gp	
Version	Datum	Änderungsprojekt	Name	00 5K12507

MHTM  
MicroDrive



Verriegelung

5526,0029

## Zur Information für die Kombination rote Baumleuchten + Verriegelung

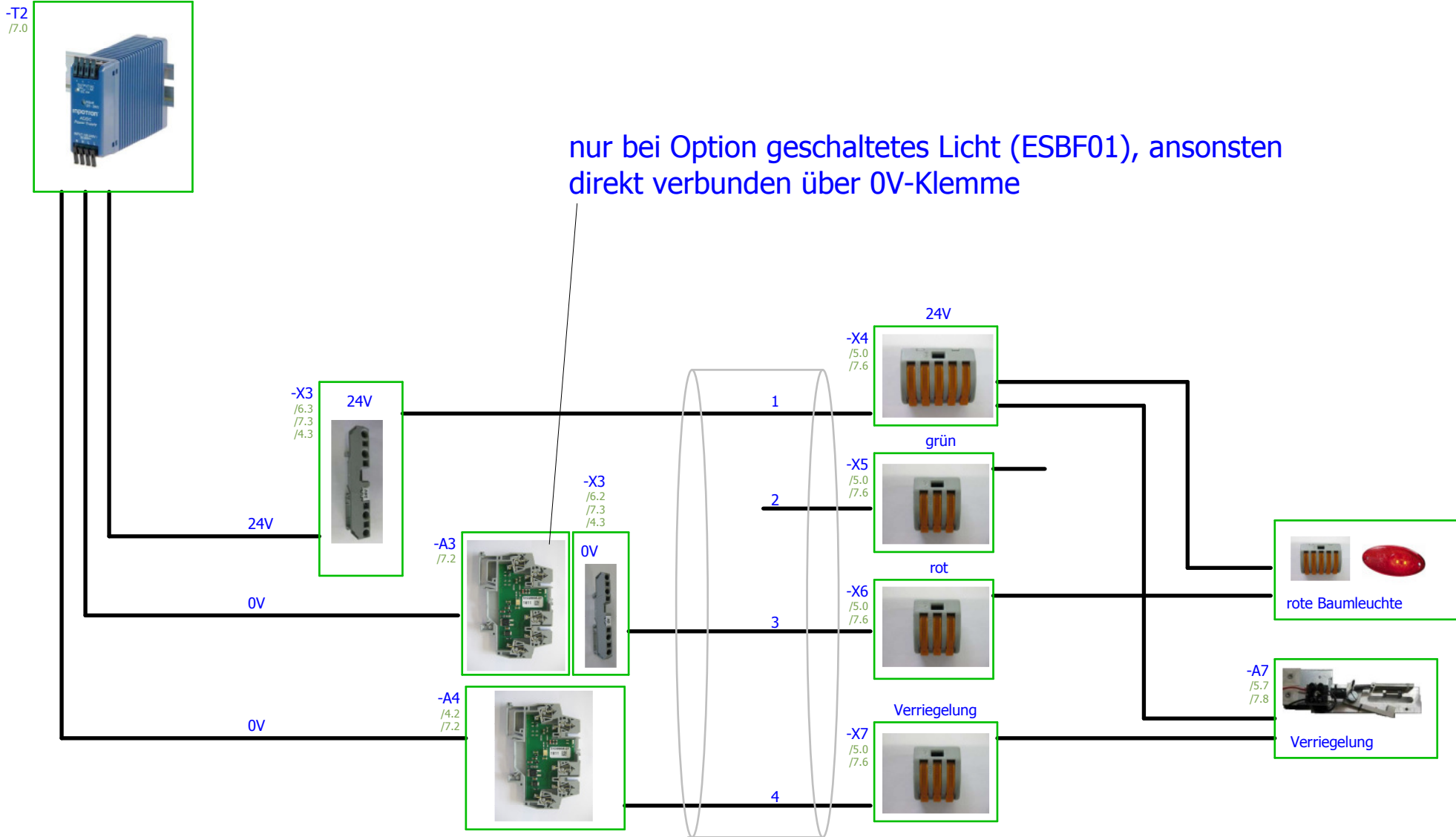

03	16.07.12	5K12526	gp	06.02.2012
02	03.07.12	5K12524	gp	gp
01	15.5.12	5K12517	gp	
Version	Datum	Änderungsprojekt	Name	00 5K12507

MHTM  
MicroDrive



Information für  
Kombination

5526,0029

Blatt 6  
Von 7

-T2  
/6.0



## Zur Information für die Kombination Leuchtstreifen + Verriegelung

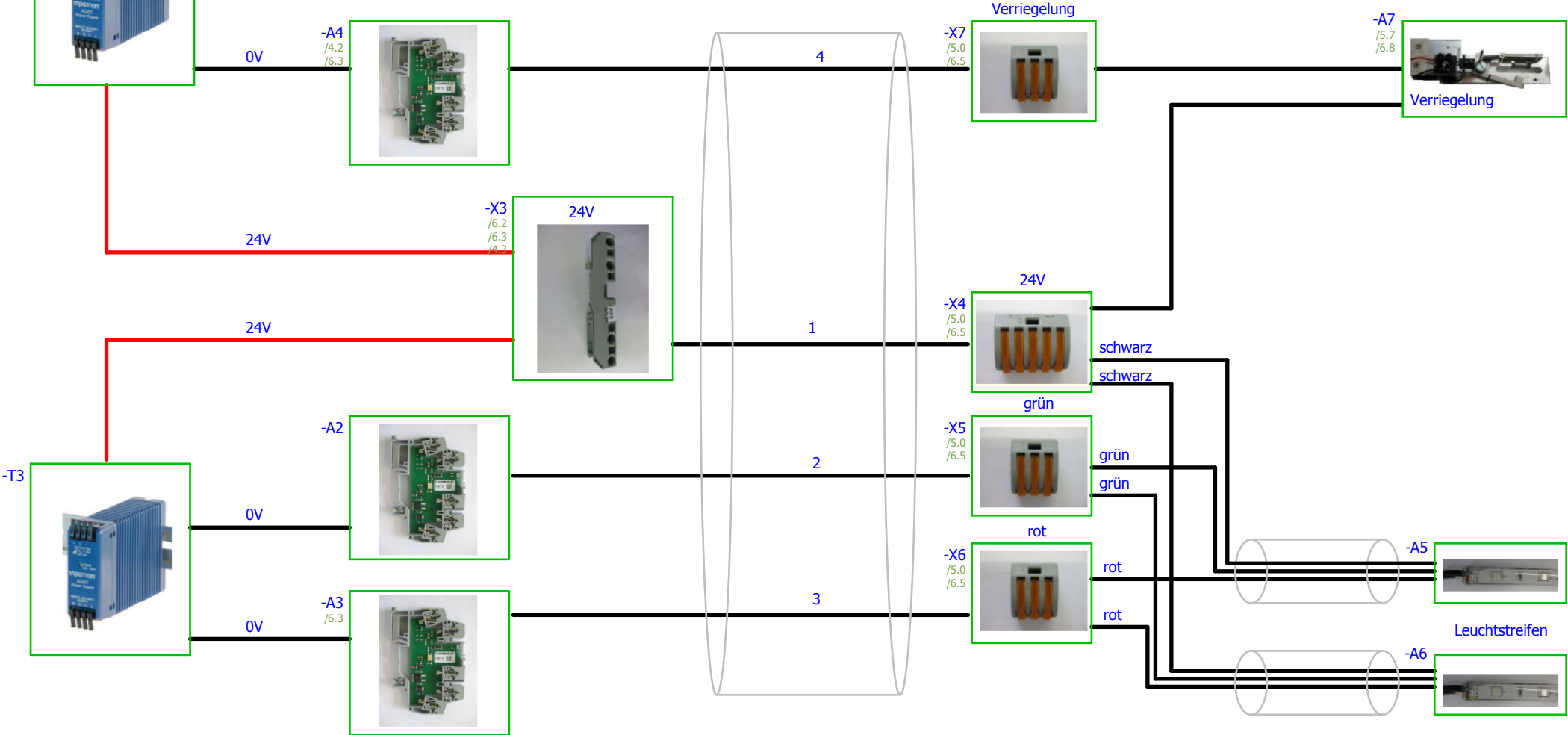

### Achtung:

Die 24V beider Netzteile werden an der Klemme X3 verbunden.  
 Die 0V beider Netzteile darf nicht verbunden werden.

03	16.07.12	5K12526	gp	06.02.2012
02	03.07.12	5K12524	gp	gp
01	15.5.12	5K12517	gp	
Version	Datum	Änderungsprojekt	Name	00 5K12507

MHTM  
MicroDrive



Information für  
Kombination

5526,0029

Blatt 7  
Von 7